

OUTLINE DIMENSIONS

MODEL EV4340X

UNIT mm

EIZO Corporation

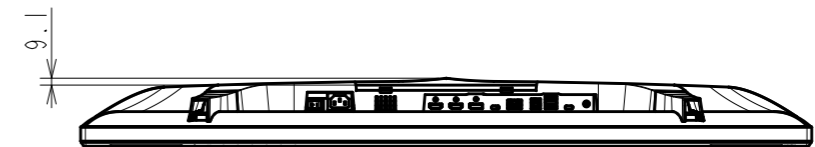
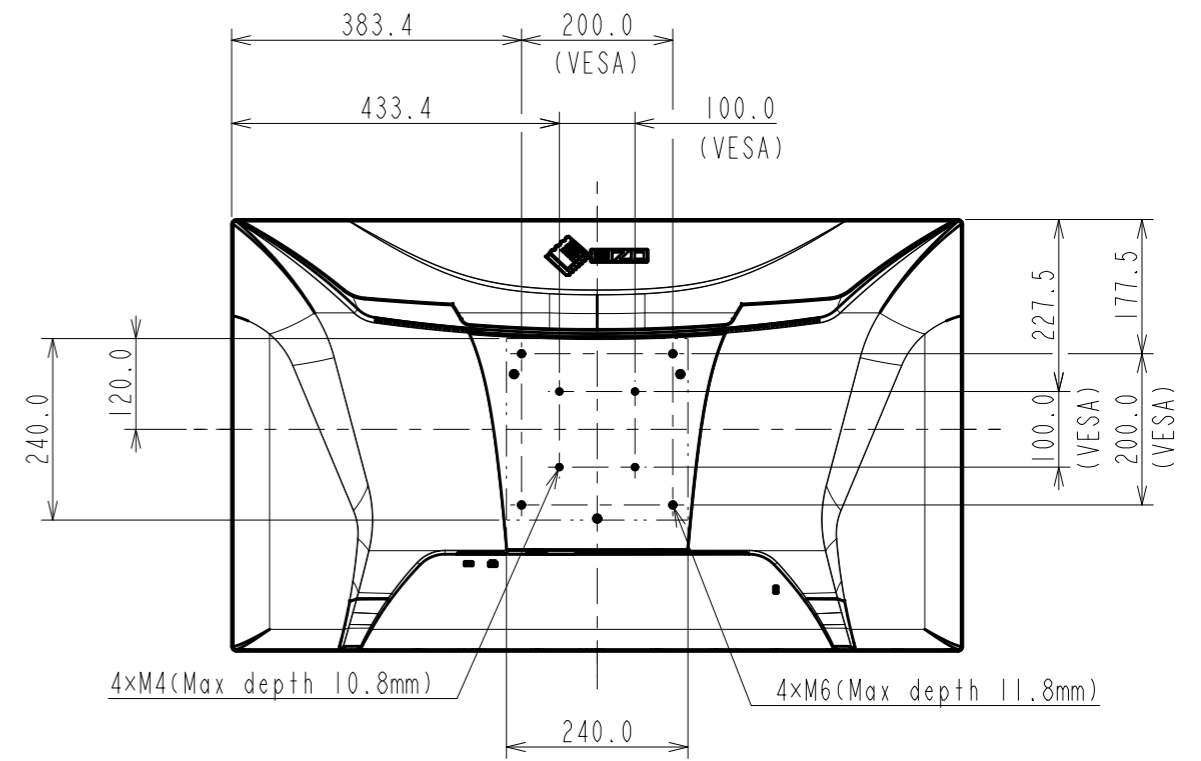
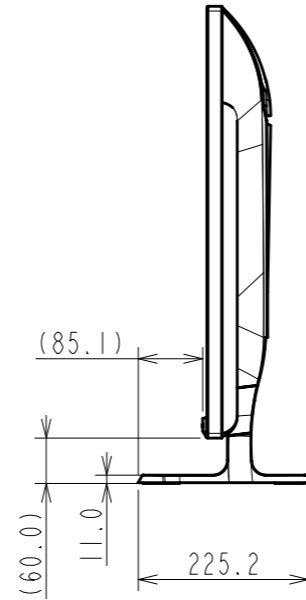
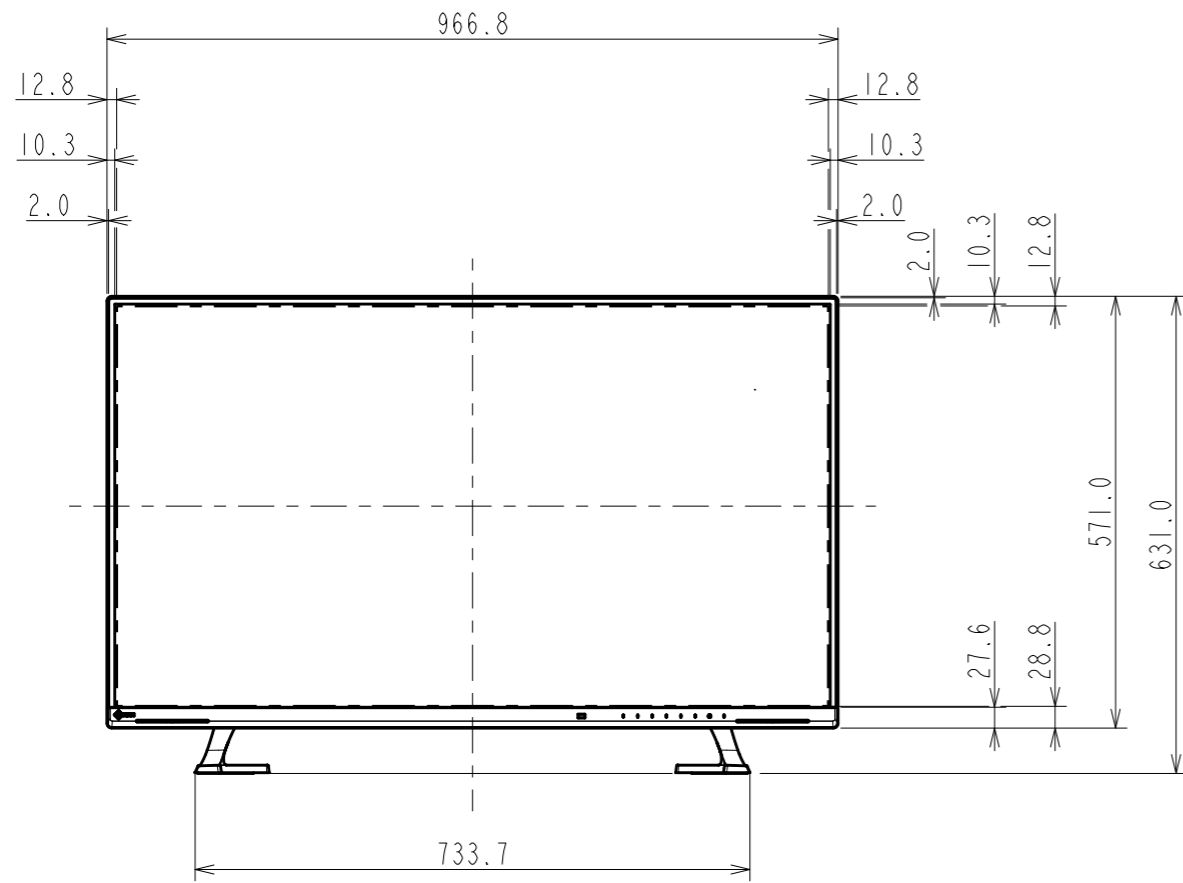
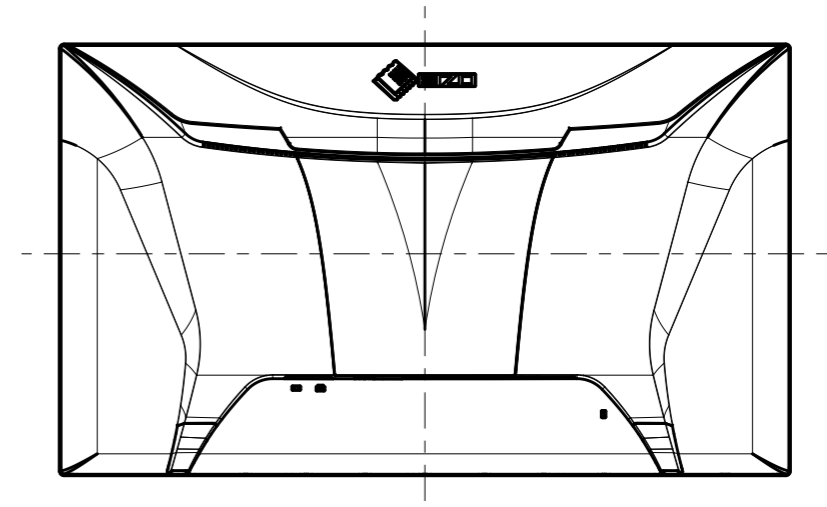
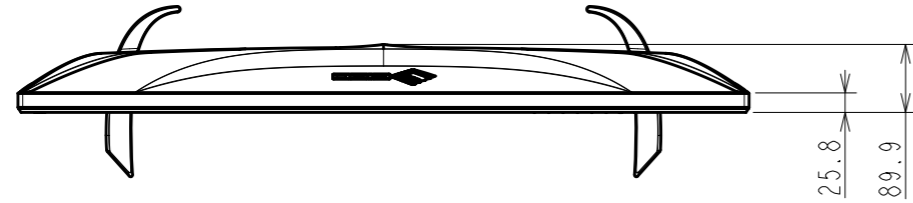

OUTLINE DIMENSIONS

MODEL EV4340X

UNIT mm

EIZO Corporation

